

MF375-2

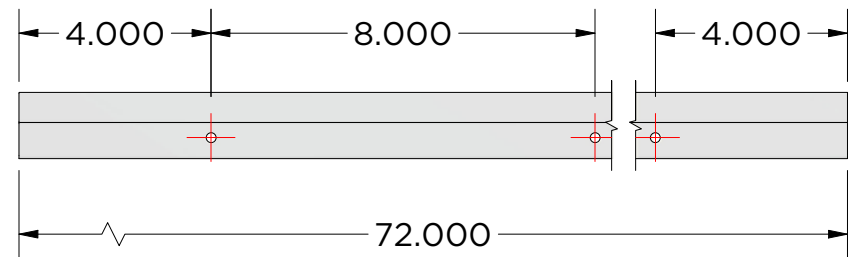

MF375-72-H8, 144

| | | | |
|------------------------------------|------------------------------------|------------------------|-------------------------|
| Created By: AMH | Approved By: AMH | Sheet Size A | Sheet No. 1/6 |
| Creation Date: 8/17/2022 | Approval Date: 8/19/2022 | Scale 1:1 | Rev |

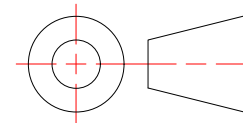

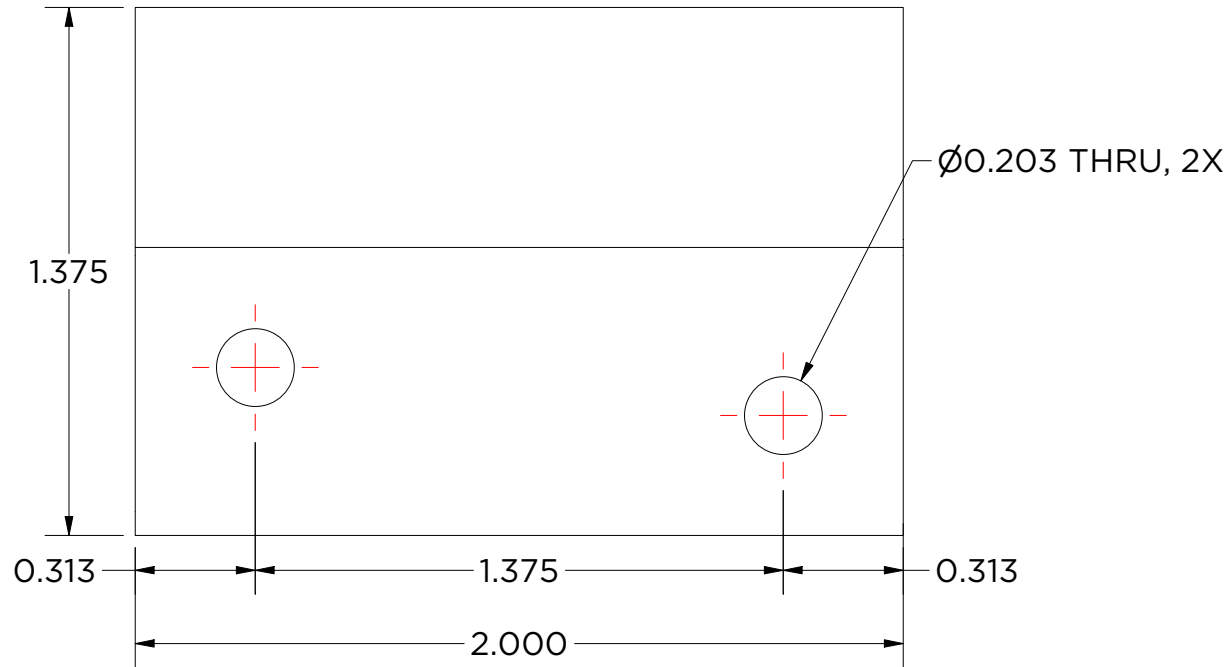
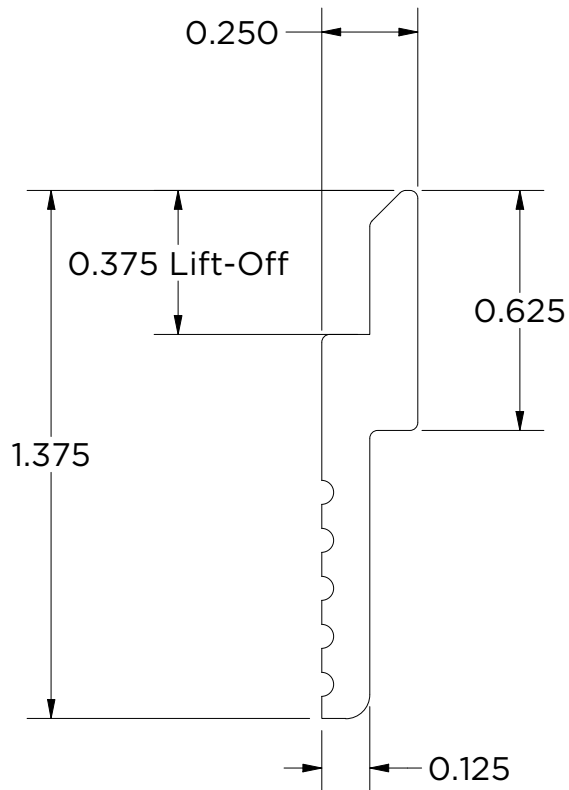

| | | | |
|------------------------------------|------------------------------------|------------------------|-------------------------|
| Created By: AMH | Approved By: AMH | Sheet Size A | Sheet No. 2/6 |
| Creation Date: 8/17/2022 | Approval Date: 8/19/2022 | Scale 2 : 1 | Rev |

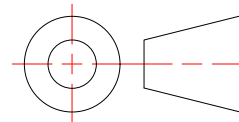

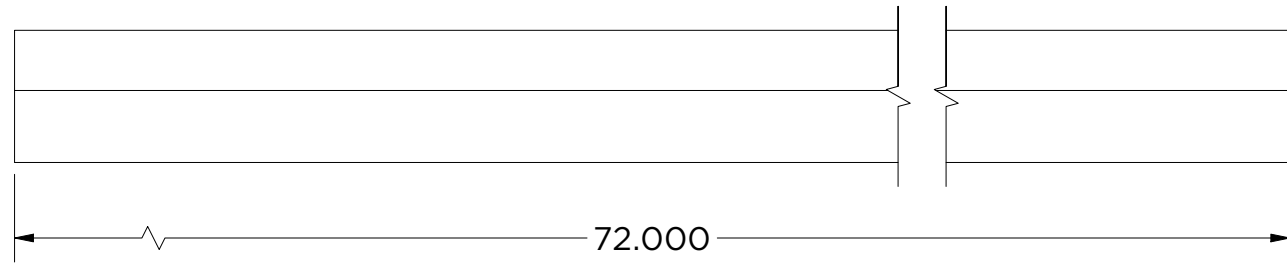
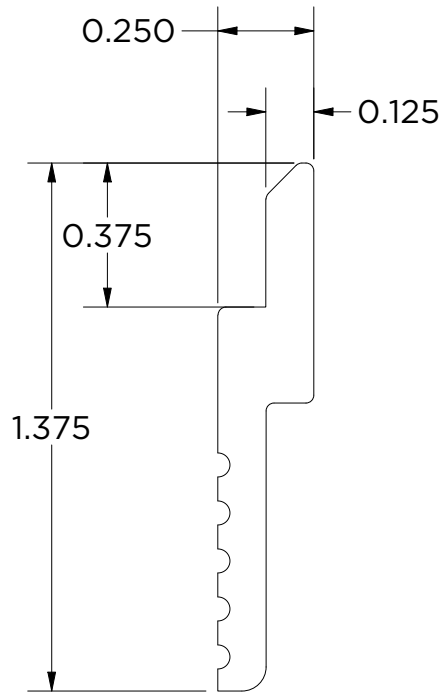

| | | | |
|------------------------------------|------------------------------------|------------------------|-------------------------|
| Created By: AMH | Approved By: AMH | Sheet Size A | Sheet No. 3/6 |
| Creation Date: 8/17/2022 | Approval Date: 8/19/2022 | Scale 1/2 | Rev |

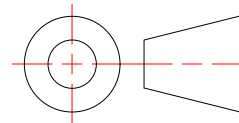

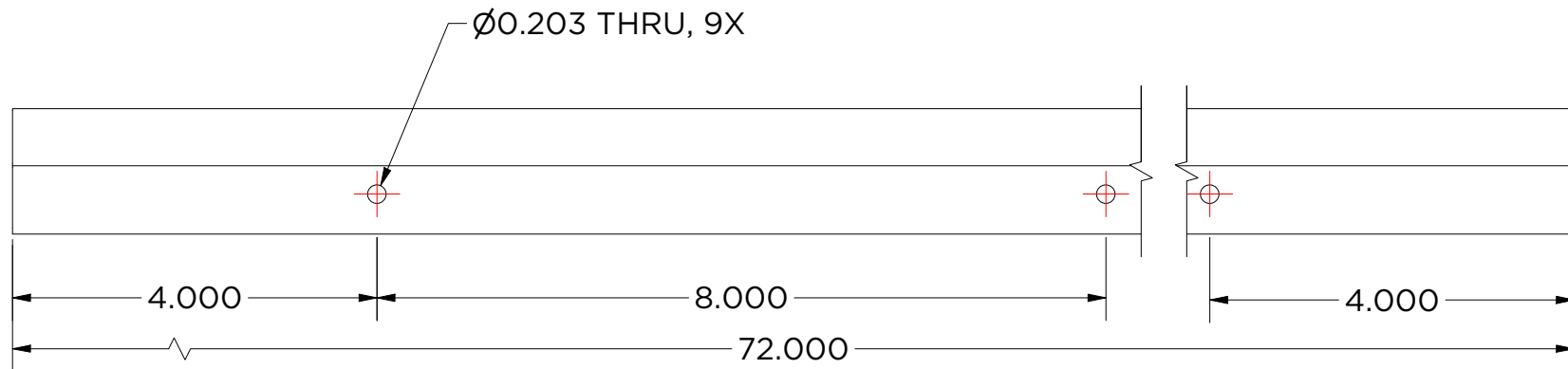
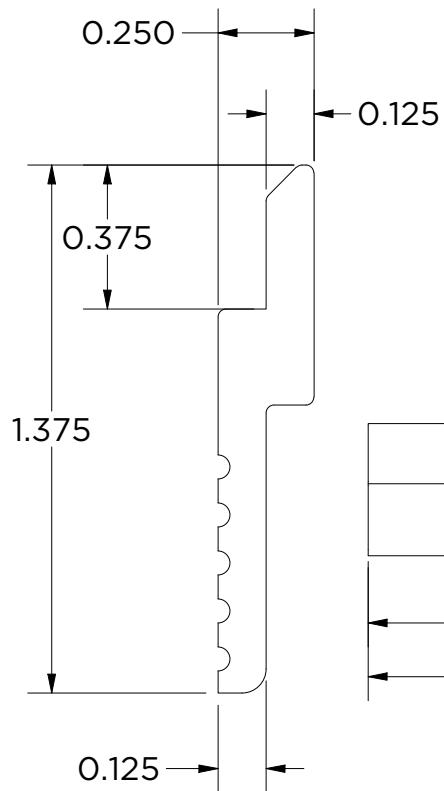

| | | | |
|------------------------------------|------------------------------------|------------------------|-------------------------|
| Created By: AMH | Approved By: AMH | Sheet Size A | Sheet No. 4/6 |
| Creation Date: 8/17/2022 | Approval Date: 8/19/2022 | Scale 2 : 1 | Rev |

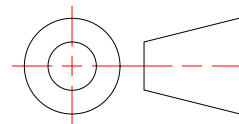

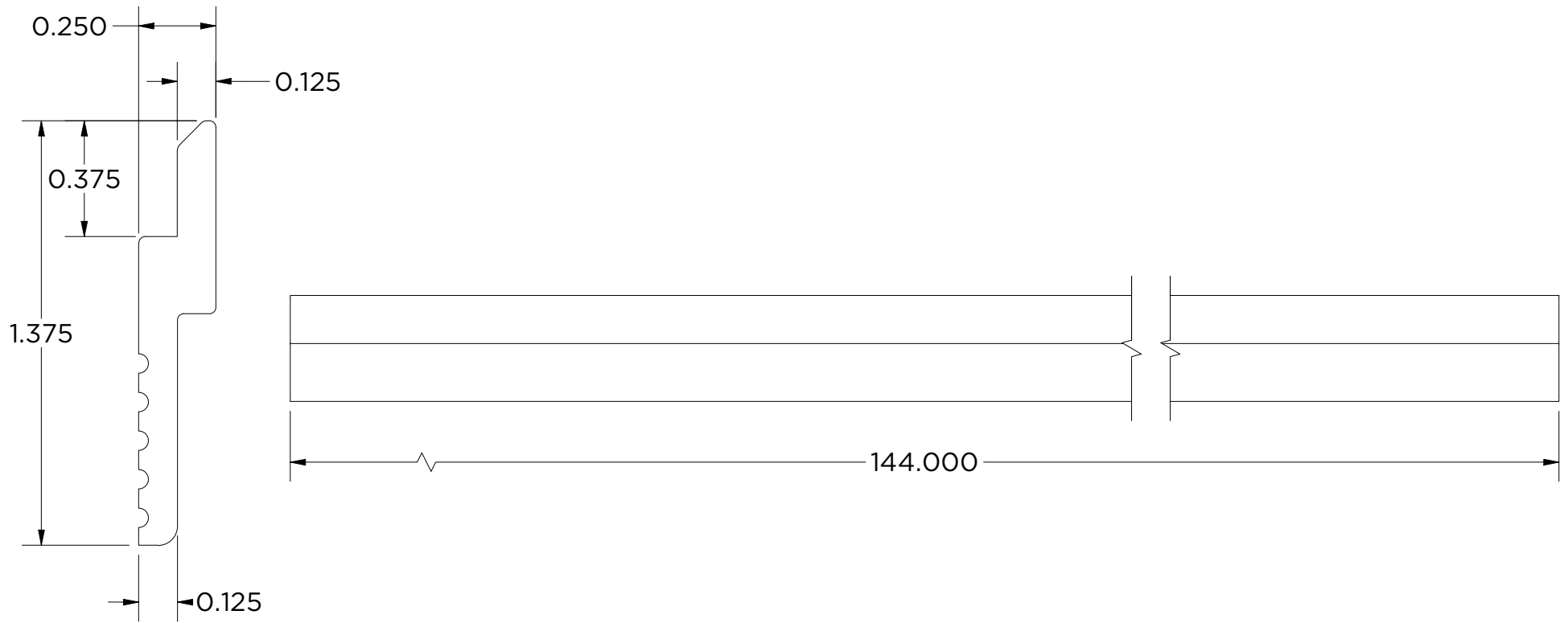

| | | | |
|------------------------------------|------------------------------------|------------------------|-------------------------|
| Created By: AMH | Approved By: AMH | Sheet Size A | Sheet No. 5/6 |
| Creation Date: 8/17/2022 | Approval Date: 8/19/2022 | Scale 2 : 1 | Rev |

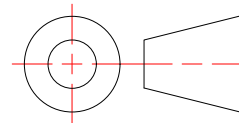

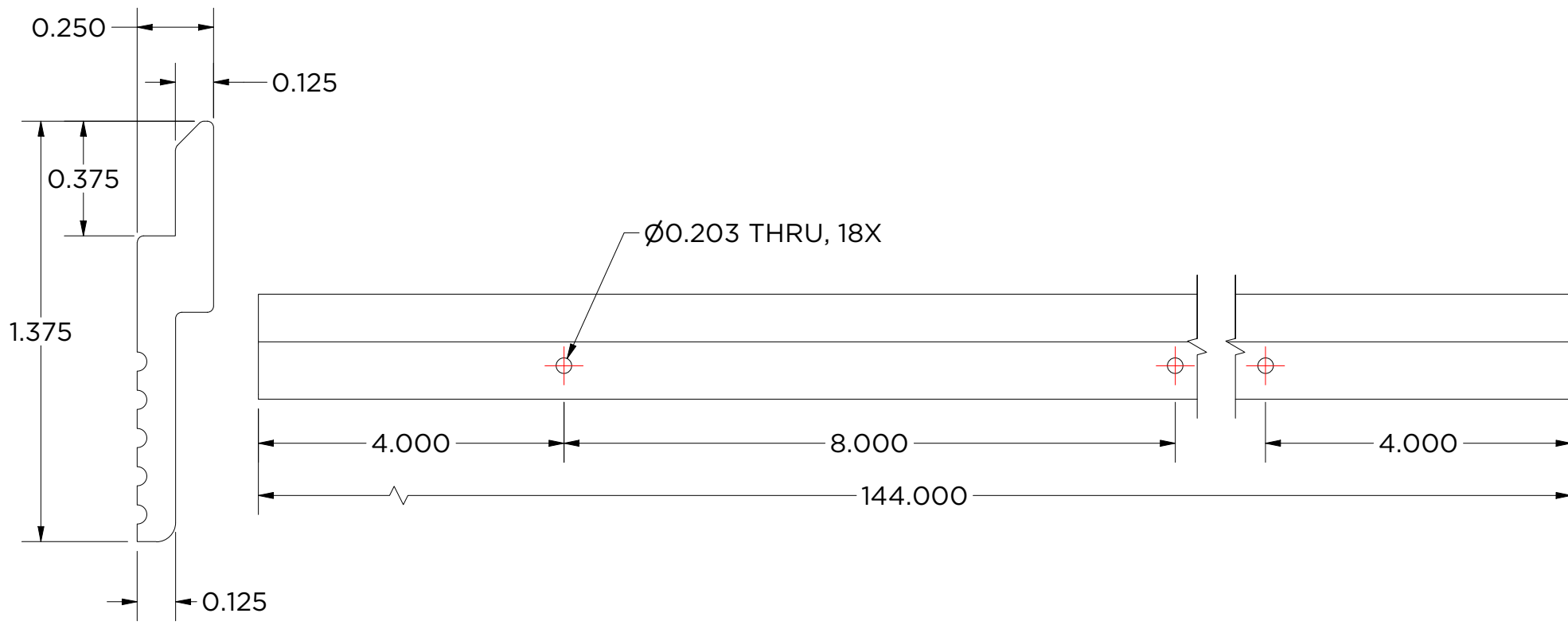

| | | | |
|------------------------------------|------------------------------------|------------------------|-------------------------|
| Created By: AMH | Approved By: AMH | Sheet Size A | Sheet No. 6/6 |
| Creation Date: 8/17/2022 | Approval Date: 8/19/2022 | Scale 2 : 1 | Rev |

