

Created By: AMH	Approved By: AMH	Sheet Size A	Sheet No. 1/7
Creation Date: 9/27/2022	Approval Date: 9/27/2022	Scale 1:1	Rev

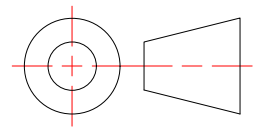

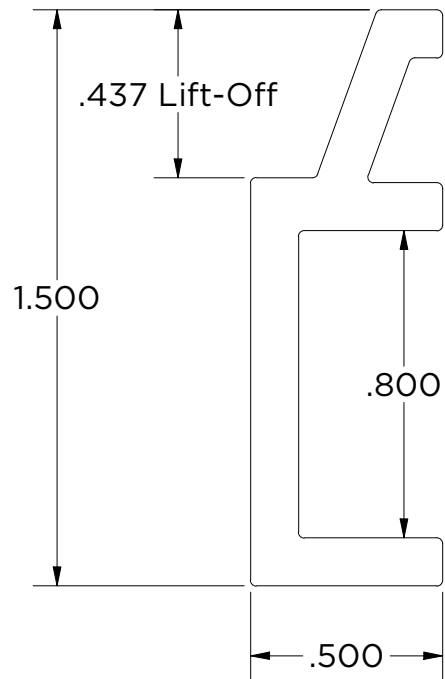

Ø.250 THRU

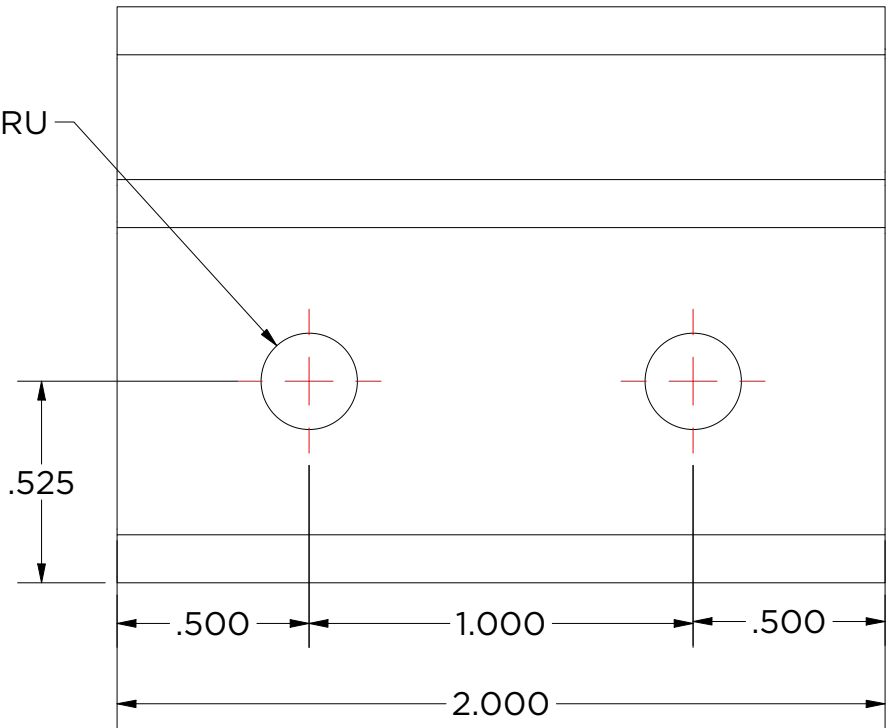

Created By: AMH	Approved By: AMH	Sheet Size A	Sheet No. 2/7
Creation Date: 9/27/2022	Approval Date: 9/27/2022	Scale 2 : 1	Rev

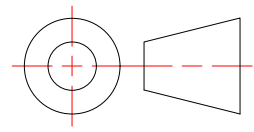

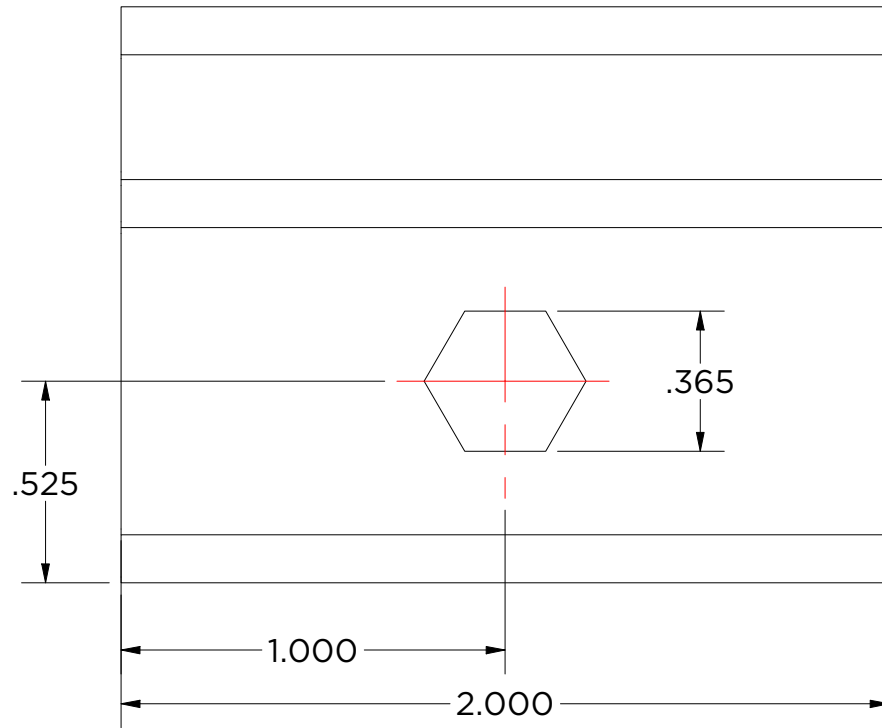
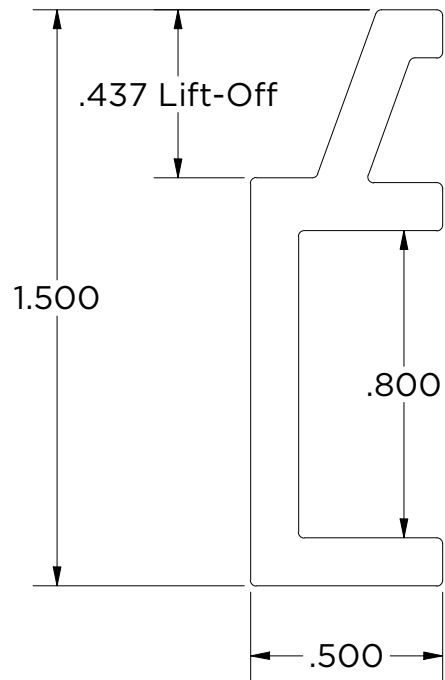

Created By: AMH	Approved By: AMH	Sheet Size A	Sheet No. 3/7
Creation Date: 9/27/2022	Approval Date: 9/27/2022	Scale 2 : 1	Rev

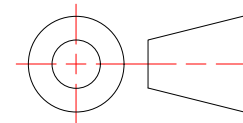

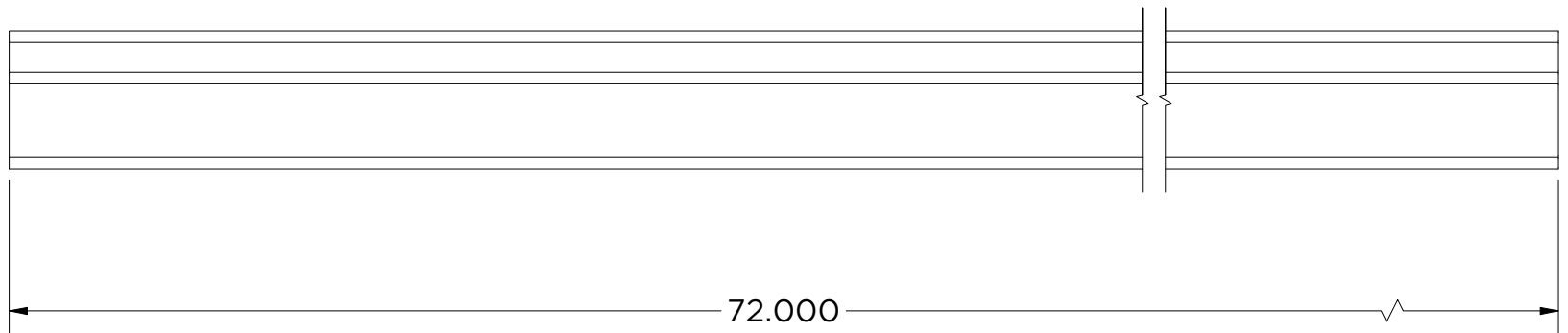
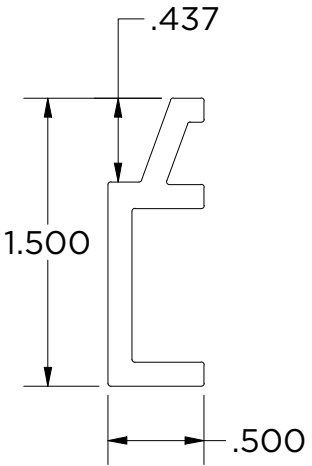

Created By: AMH	Approved By: AMH	Sheet Size A	Sheet No. 4/7
Creation Date: 9/27/2022	Approval Date: 9/27/2022	Scale 1:1	Rev

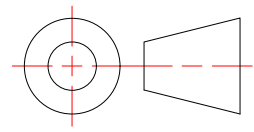

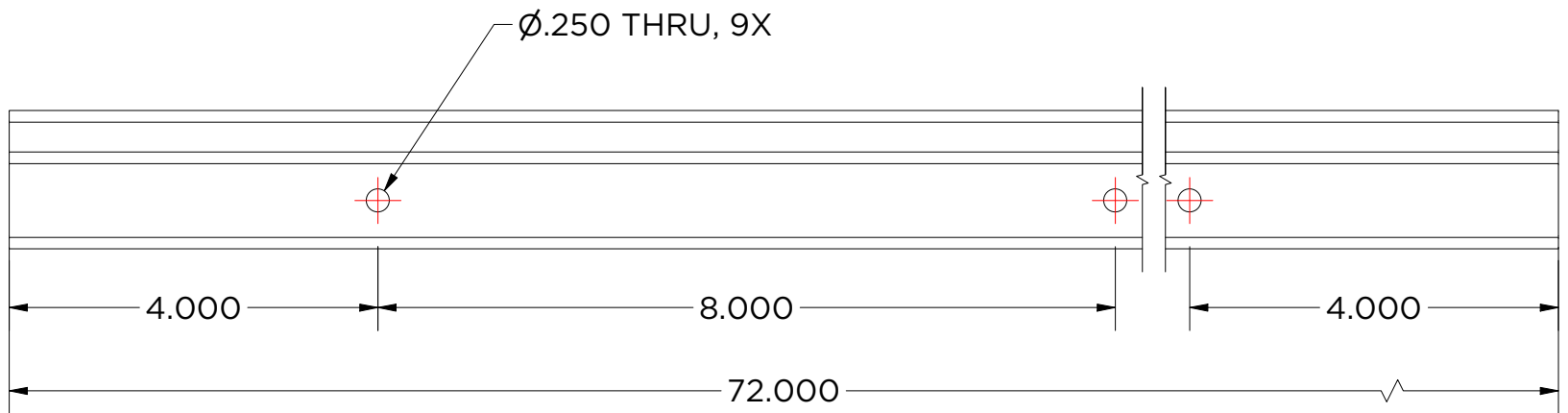
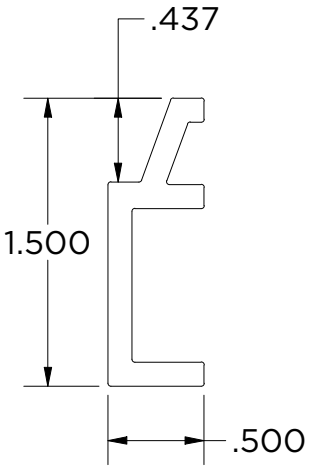

Created By: AMH	Approved By: AMH	Sheet Size A	Sheet No. 5/7
Creation Date: 9/27/2022	Approval Date: 9/27/2022	Scale 1:1	Rev

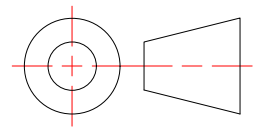

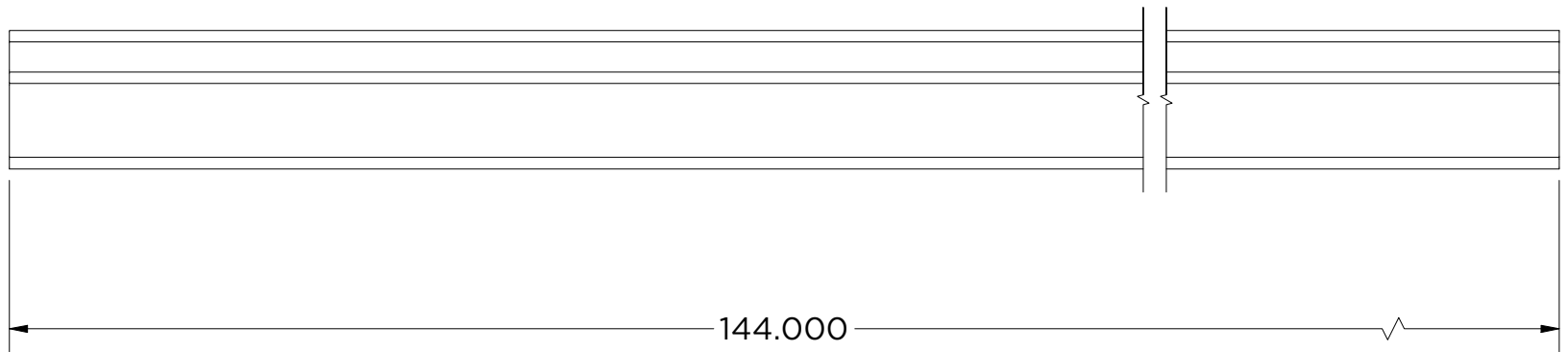
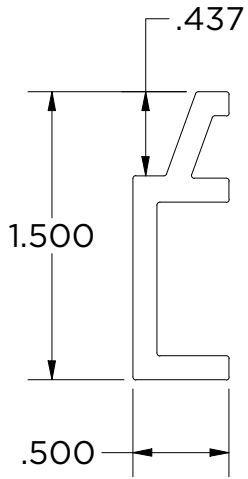

Created By: AMH	Approved By: AMH	Sheet Size A	Sheet No. 6/7
Creation Date: 9/27/2022	Approval Date: 9/27/2022	Scale 1:1	Rev

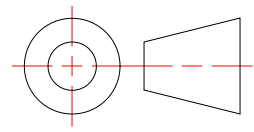

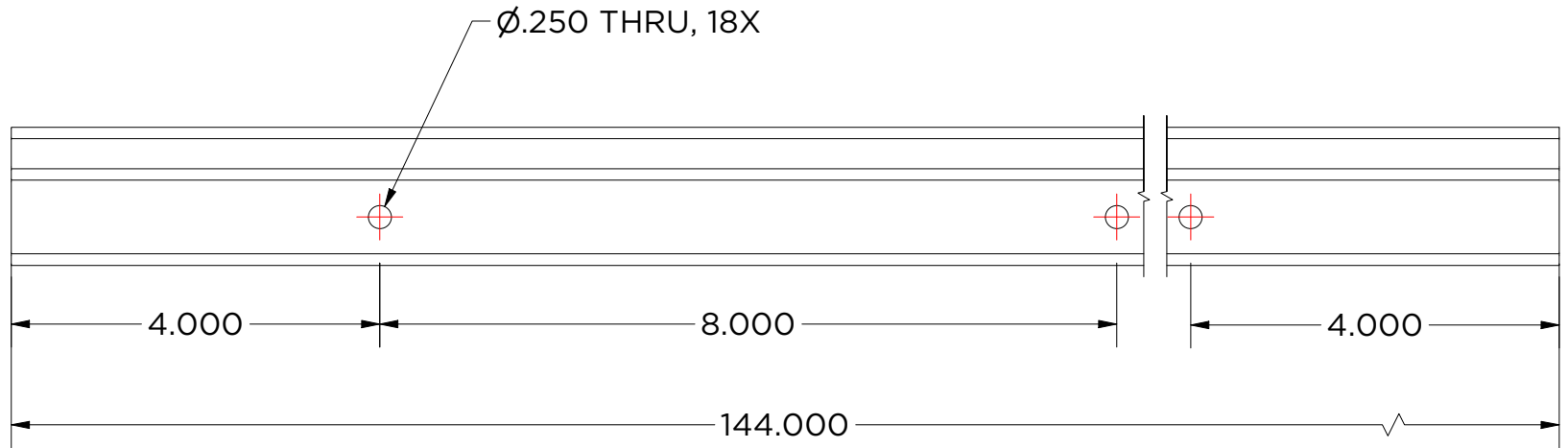
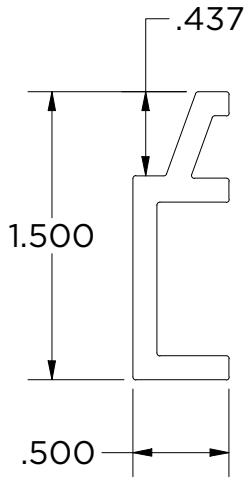

Created By: AMH	Approved By: AMH	Sheet Size A	Sheet No. 7/7
Creation Date: 9/27/2022	Approval Date: 9/27/2022	Scale 1:1	Rev

